

# WI creations

Special Constructions and effects



**General:**

U2, the Irish super band, started its tour through Europe and North America on 30 June 2009.

The eyecatcher of the concert, apart from the huge stage, is a vertically extending oval screen with a cross section of 25 by 16 meters. The screen itself, the result of a totally new technique by Innovative Designs, a sister company of Barco, was fixed to a supporting construction developed and built by WICreations.

This construction not only supports the screen, but also incorporates all cables and electronics extending with the screen up to 22 m high. The height of the folded screen is 6 m.

Apart from the usual structural and technical requirements, quick assembly and repackaging of the screen and the support construction were imperatives. This also proved a success. The whole screen can be built up within 6 hours.

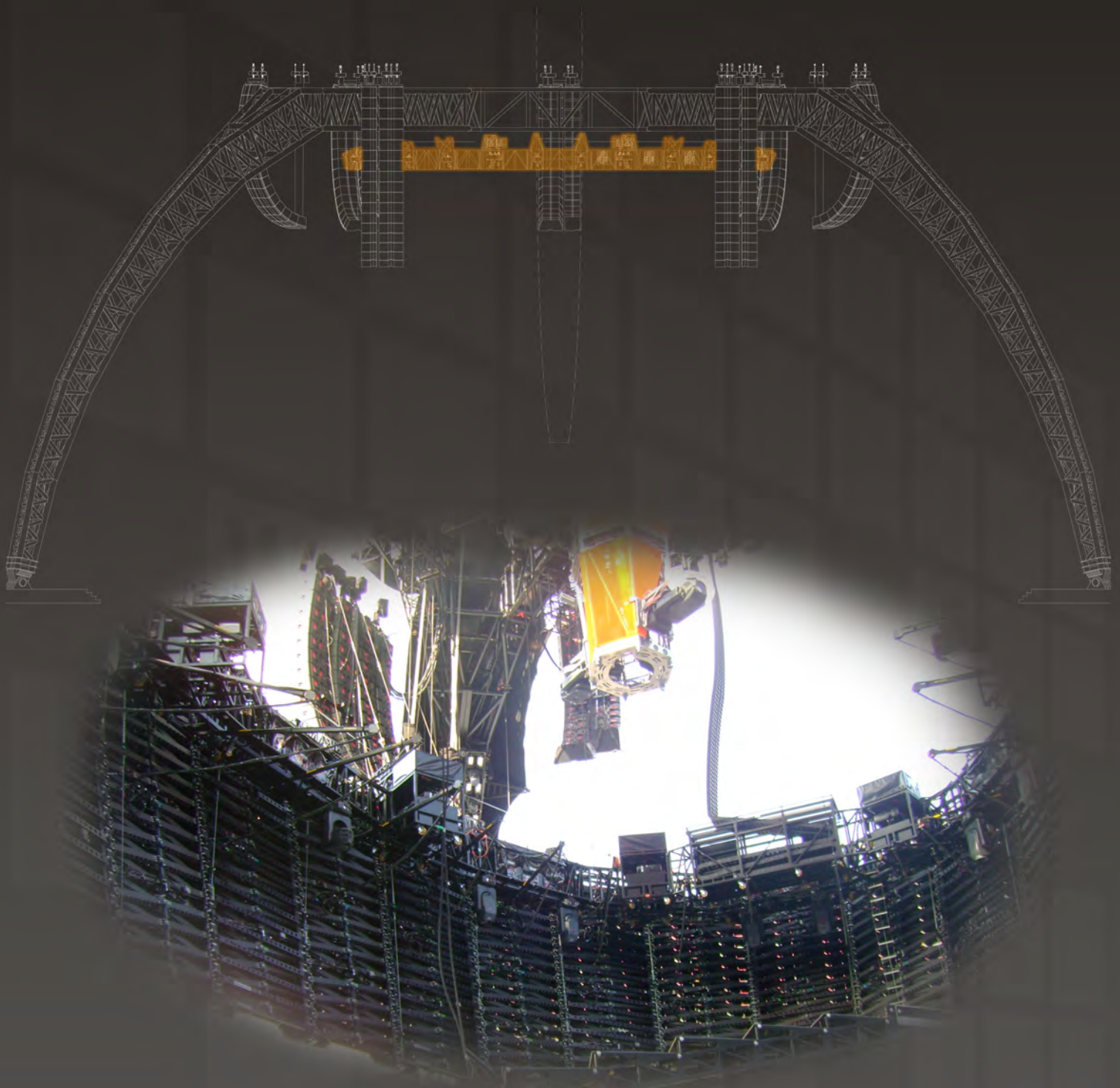

**Technical:**

The video screen truss is designed and calculated by Wcreations to carry the video screen and all the necessary equipment like the video controllers, power supplies and 25 km of cable as well as the automated hoists that open the screen. In use the video screen truss hangs on eight automation winches from the main structure.

**Measurements:**

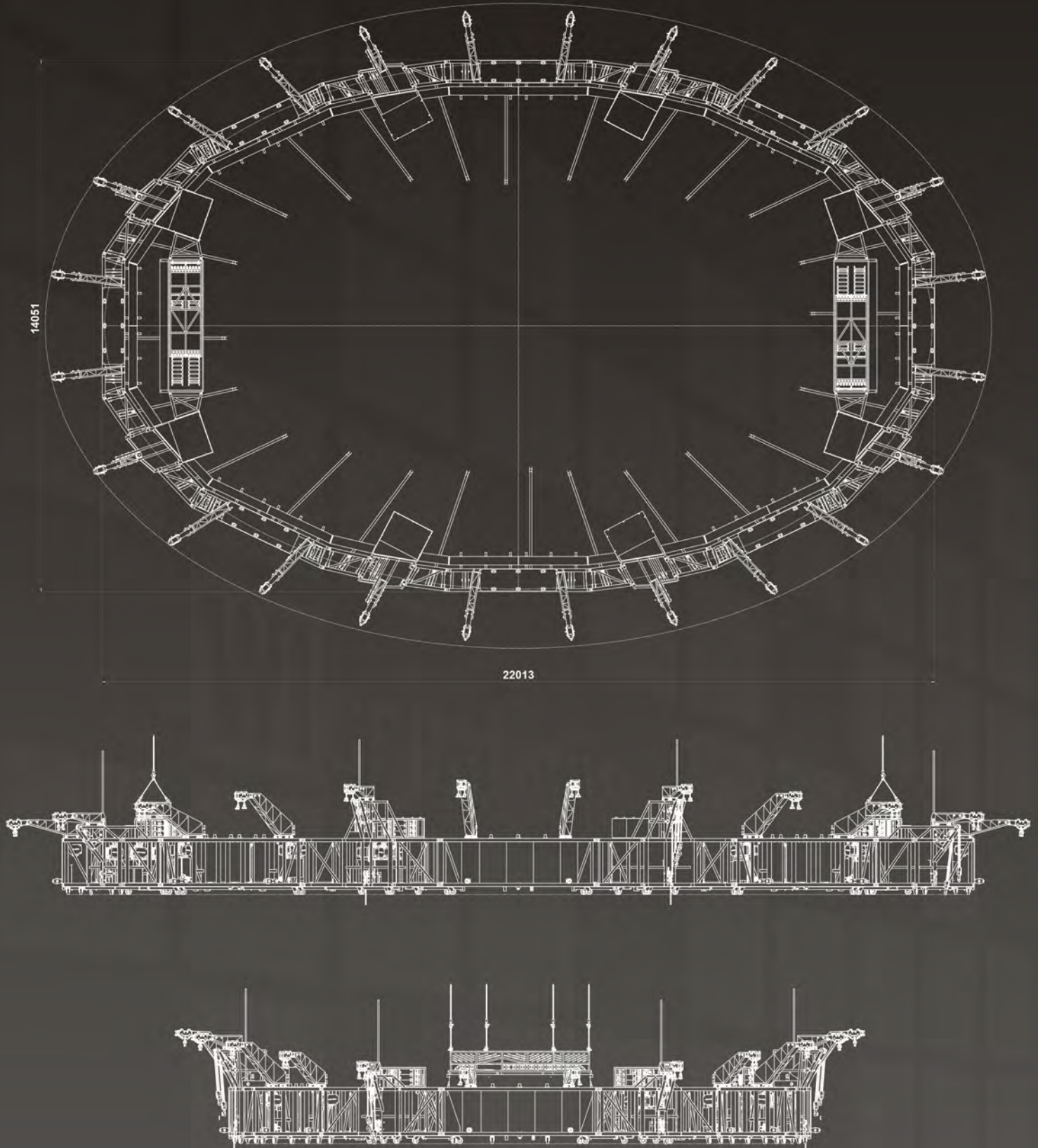

## Complete truss:

The video screen truss consists of:

- 8x main spur
- 8x video spur
- 16x infill
- 24x gallows (incl. trolley beam & trolley)
- 2x cable way bucket
- 4x infill cable way bucket
- 24x gallows tubes
- 32x catwalk parts
- 24x cable sticks
- All necessary pins and safety's

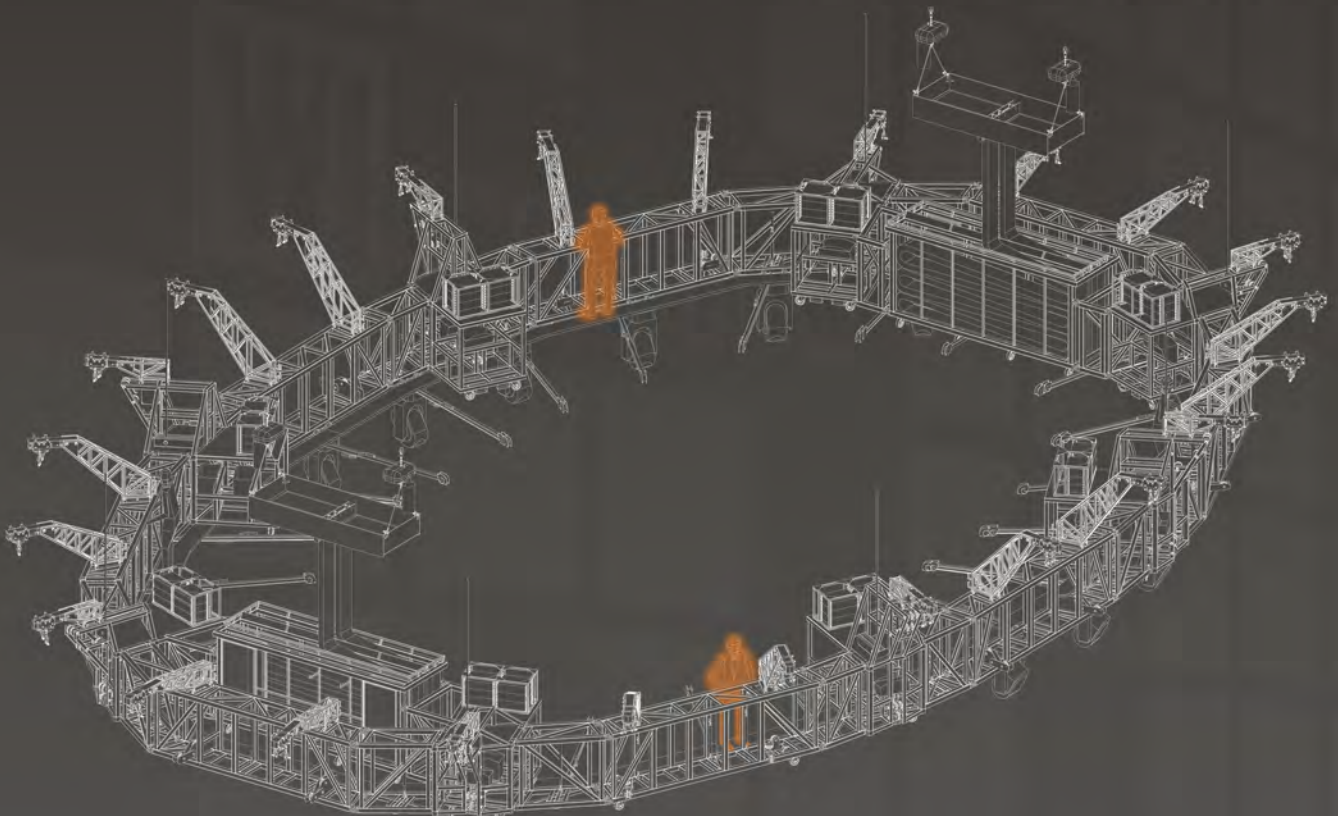
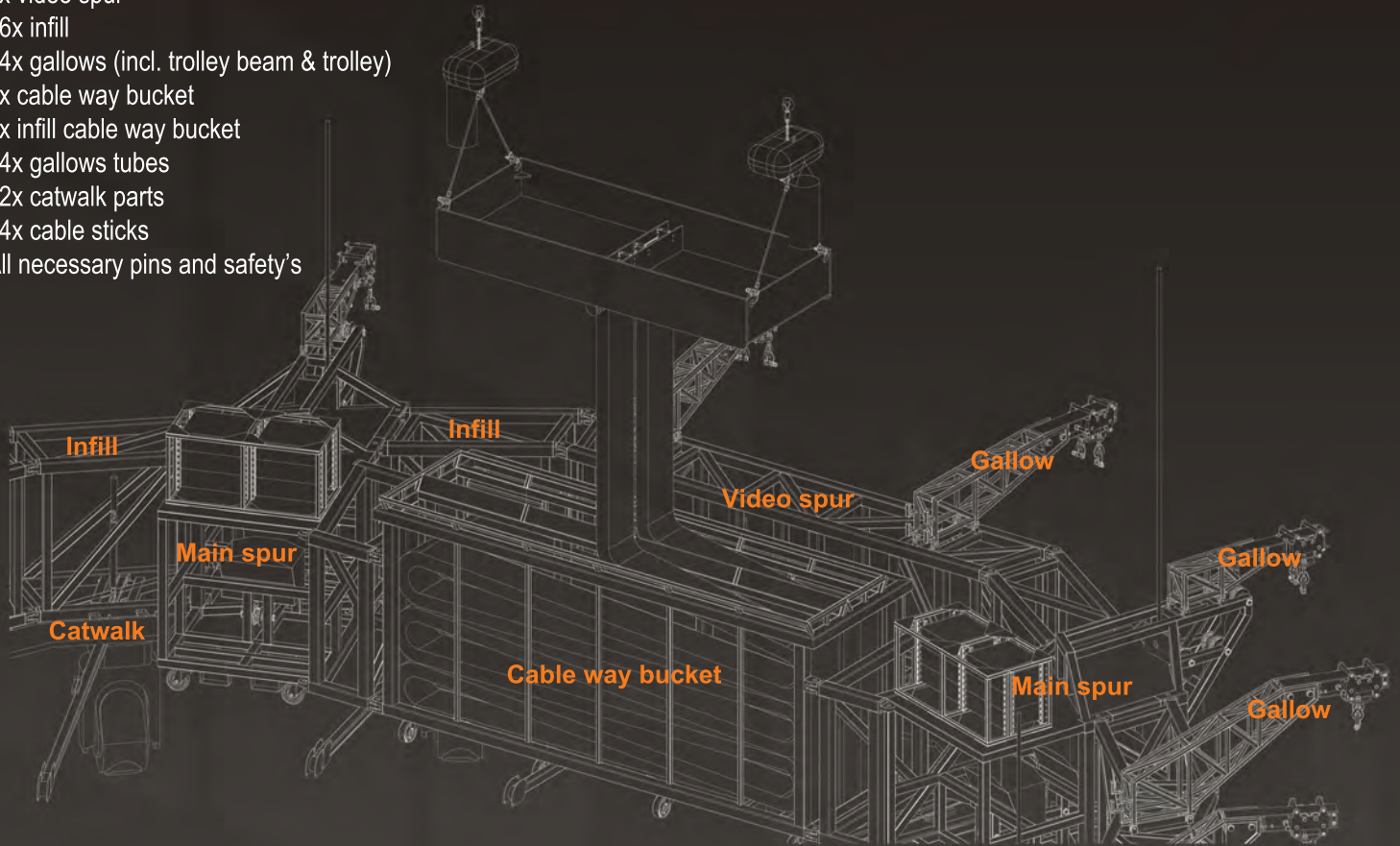

**Parts:**

**The video spur**

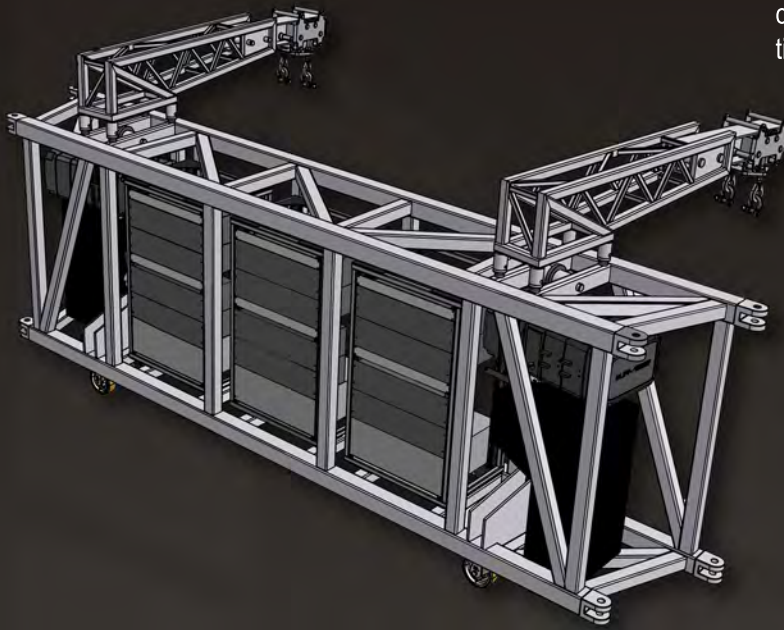

Quick assembly and repackaging of the screen and the support construction were imperatives, so every component is built to save time and space during load-in and load-out.

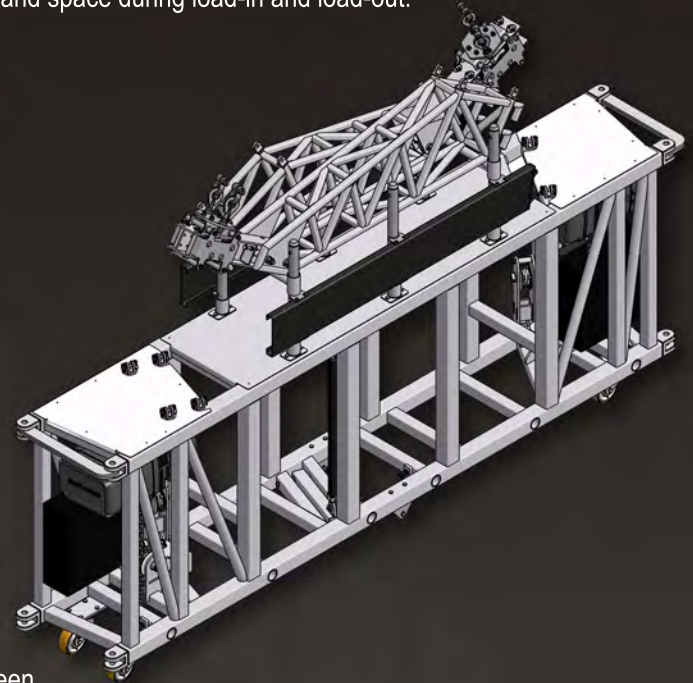

There are 4 different shaped video spurs to create the oval shape of the screen. The video spur holds the video controllers installed by BARCO and their necessary power supplies.

**The main spur**

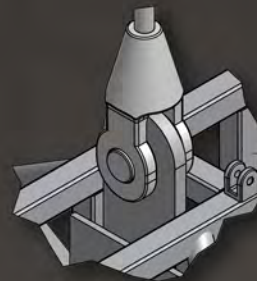
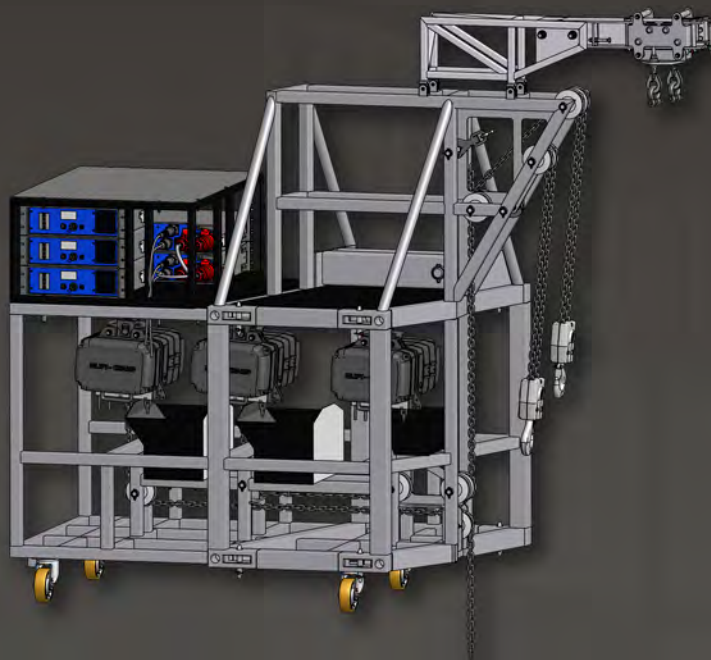

Winch cable connection

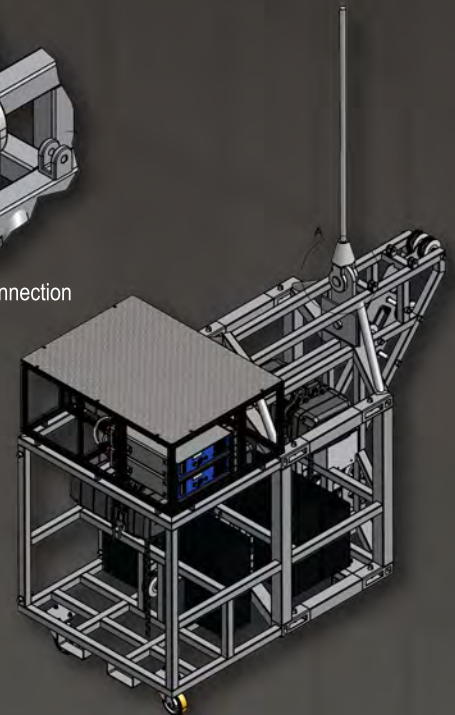

The main spurs are connected with the rest of the enormous stage with a winch cable to move the screen up and down. Wlcreations triple reeved the eight 2,5 tonne chain hoists in order to make that happen. The 8 main spurs had to be made out of steel to increase the strength and safety; all the other spurs are aluminum. Also the motion controllers to open and close the screen are located here together with their power supplies.

**The cable way bucket**

The cable way bucket holds the cable that delivers the power to the screen, The top section is connected to the main structure of the stage, and the bucket moves up and down with the screen.

Also connectors for the motion en video controllers are foreseen.

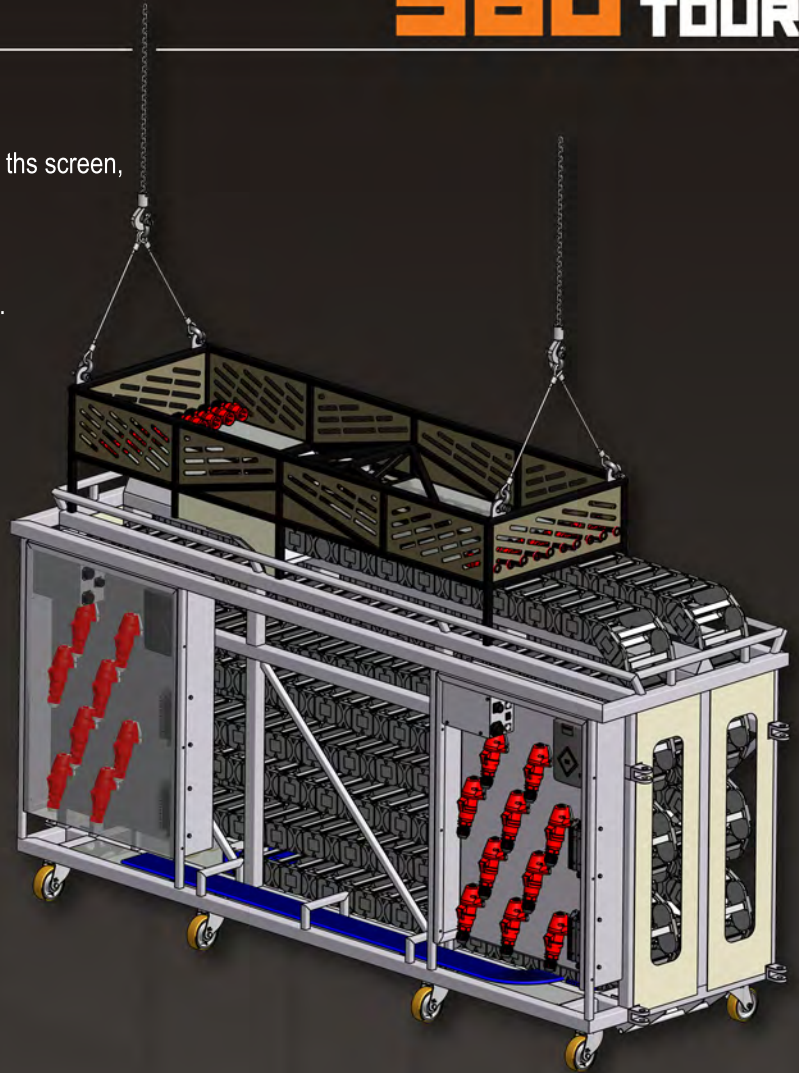
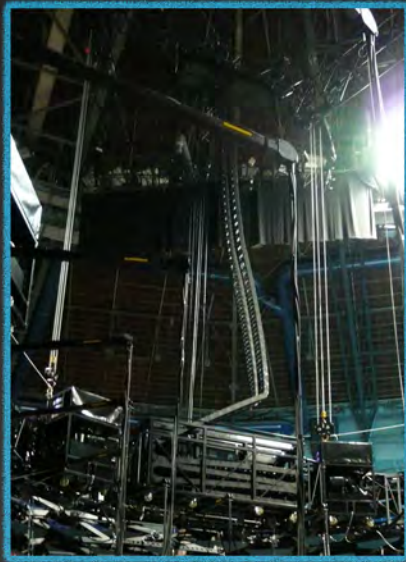

**Infill elements**

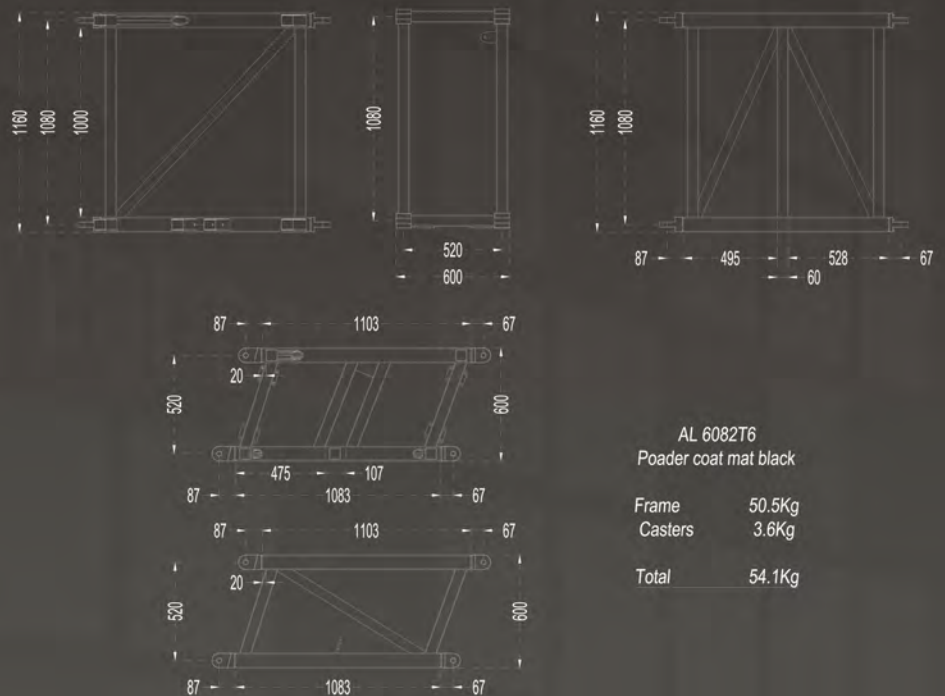
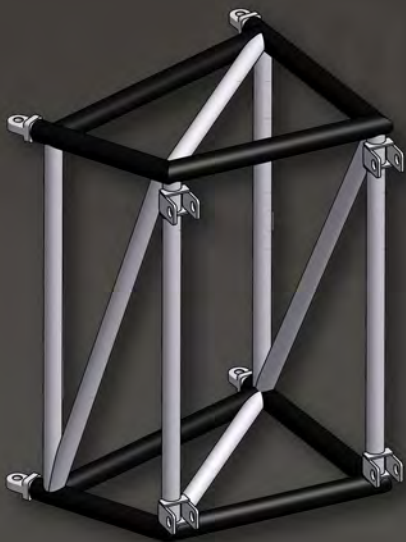

Example: Infill for the cable way bucket

The Infill elements are used to connect the main spurs to the video spurs and they help to accomplish the oval shape of the screen. There are 16 infill's in total.

**Construction:**

Welding the spurs and gallows



Truss assembly



Testbuild @ sportpaleis Antwerp

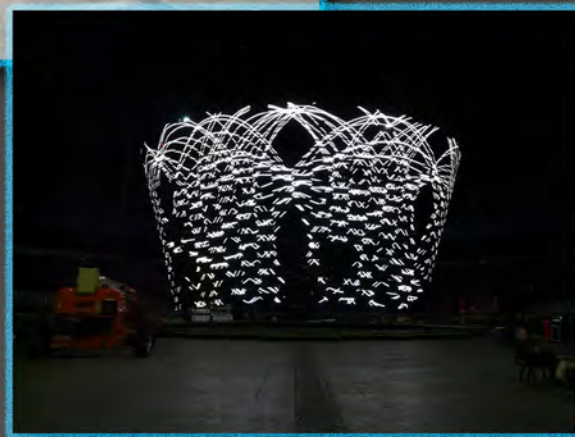
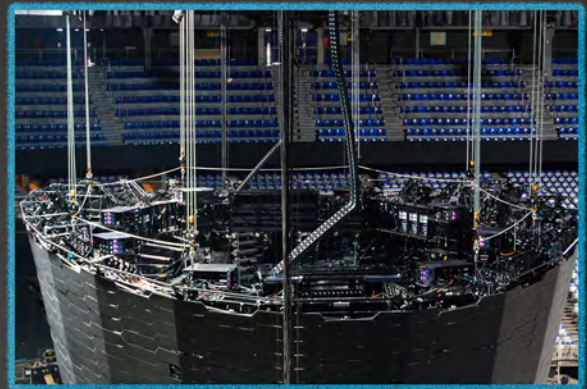
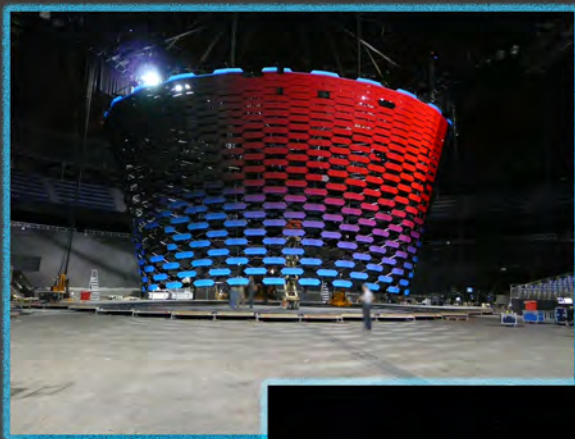
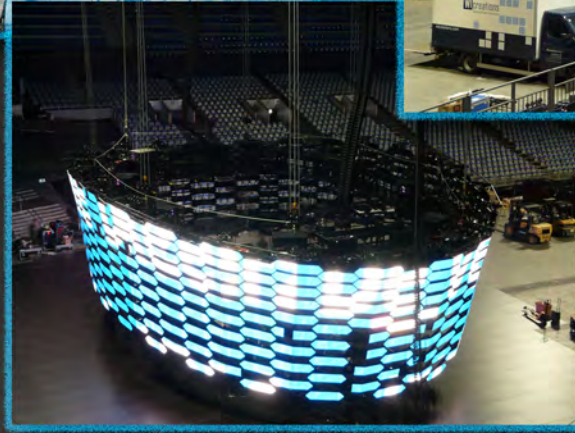
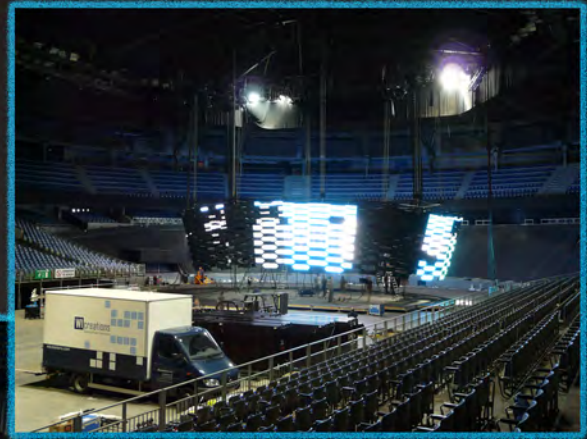
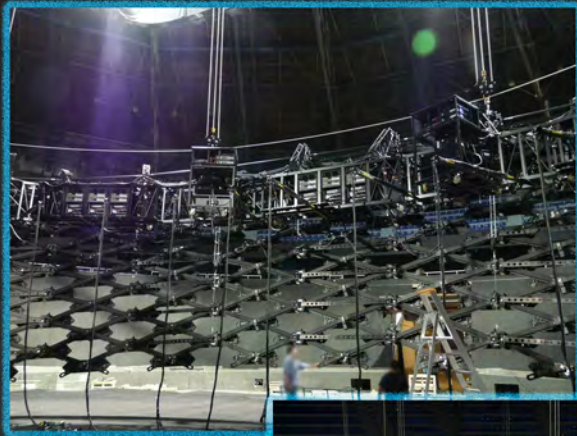

The show @ Barcelona:

Load In

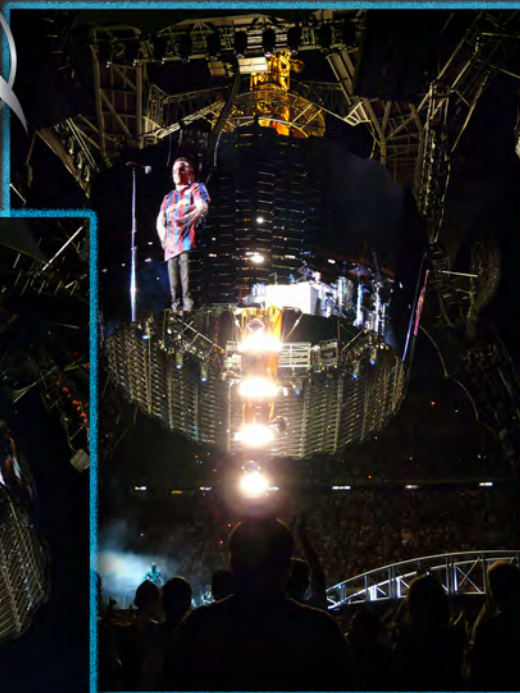
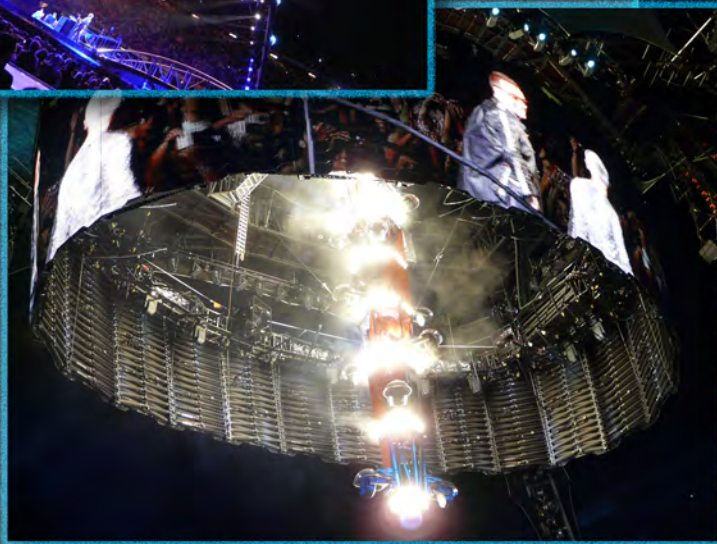
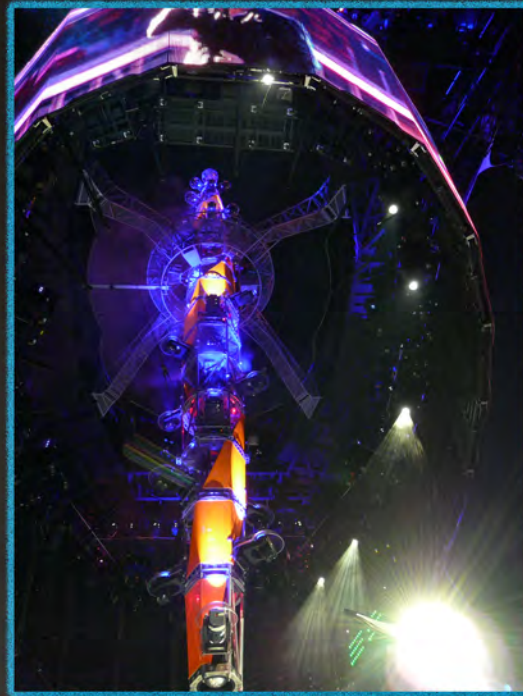

- Barcelona, Spain
- Milan, Italy
- Paris, France
- Nice, France
- Berlin, Germany
- Amsterdam, Netherlands
- Dublin, Ireland
- Gothenburg, Sweden
- Gelssenkirchen, Germany
- Chorzow, Poland
- Zagreb, Hungary
- London, England
- Glasgow, England
- Sheffield, England
- Cardiff, England
- Chicago, IL
- Toronto, ON
- Boston, MA
- E. Rutherford, NJ
- Washington, DC
- Charlottesville, VA
- Raleigh, NC
- Atlanta, GA
- Tampa, FL
- Dallas, TX
- Houston, TX
- Norman, OK
- Phoenix, AZ
- Las Vegas, NV
- Los Angeles, CA
- Vancouver, BC
- Anaheim, CA
- Denver, CO
- Oakland, CA
- Seattle, WA
- Edmonton, Canada
- Minneapolis MN
- East Lansing, MI
- Toronto, ON
- Chicago, IL
- Miami, FL
- Philadelphia, PA
- Montreal, Canada
- New York, NY
- Turin, Italy
- Frankfurt, Germany
- Hannover, Germany
- Horsens, Denmark
- Helsinki, Finland
- Moscow, Russia
- vienna, Austria
- Athens, Greece
- Istanbul, Turkey
- Munich, Germany
- Paris, France
- Brussels, Belgium
- San Sebastian, Spain
- Seville, Spain
- Coimbra, Portugal
- Rome, Italy

Wicreations BVBA  
Astridstraat 25  
B-3120 Tremelo  
T: +32 (0) 16 75 03 77  
F: +32 (0) 16 79 52 69  
info@wicreations.com

www.wicreations.com